

Model SHX-GF5-2 DC-2GHz 2 Watts

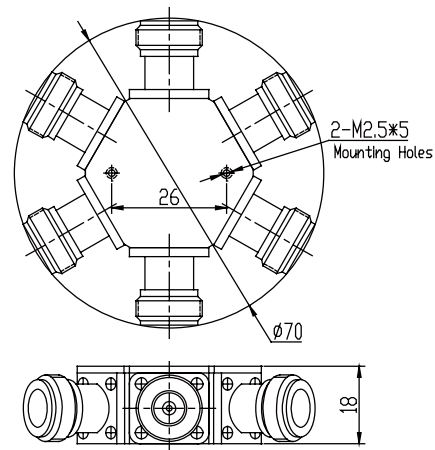

Power splitters can divide one signal into two or N way equal or non-equal energy, in reverse, they are also used as combiners by combining multiple signal into one.

SHX-GF5-2 resistive power splitter is used in broad-band transmission and reflect coefficient test by separating signals in order to test and accurately distribute one signal to antennas. The features include: small dimensions and light, high power resistance and high temperature.

MECHANICAL SPECIFICATIONS

Connectors	Female Pin	Housing	Temp Range	Dimensions	Weight
Brass Nickel Plated	Beryllium Copper Gold Plated	Aluminum, Anodic Oxidation	Operating: -10°C~+50°C Non-operating: -40°C~+70°C	Ø70×18mm	140g

RoHS Compliant: Yes

ELECTRICAL SPECIFICATIONS

Model Number	Frequency Range(GHz)	Max VSWR	Insertion Loss(dB)
SHX-GF5-2	DC-1	1.2	14±0.5
	1-2	1.3	14±1.5

NOMINAL IMPEDANCE: 50Ω, 75Ω

AVERAGE POWER: 2W

CONNECTOR TYPE: N(F), SMA(F), F(F)

Notes:

1. Dimensions Tolerance ±2%
2. Dimensions and specifications refer to connector type N unless otherwise specified